

Section -A

SECTIONS		Page:4.1
Drawn by: Tarmo Tigane	STUDLAND 4x4	Measure: 1:50

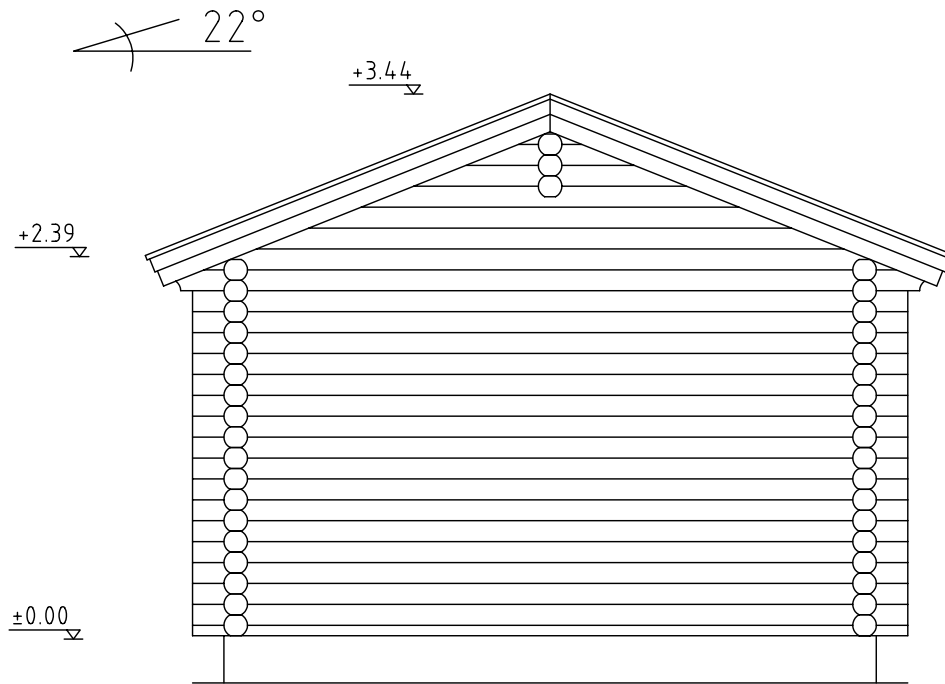

Section -B

SECTIONS		Page:4.1.1
Drawn by: Tarmo Tigane	STUDLAND 4x4	Measure: 1:50

+3.44

±0.00

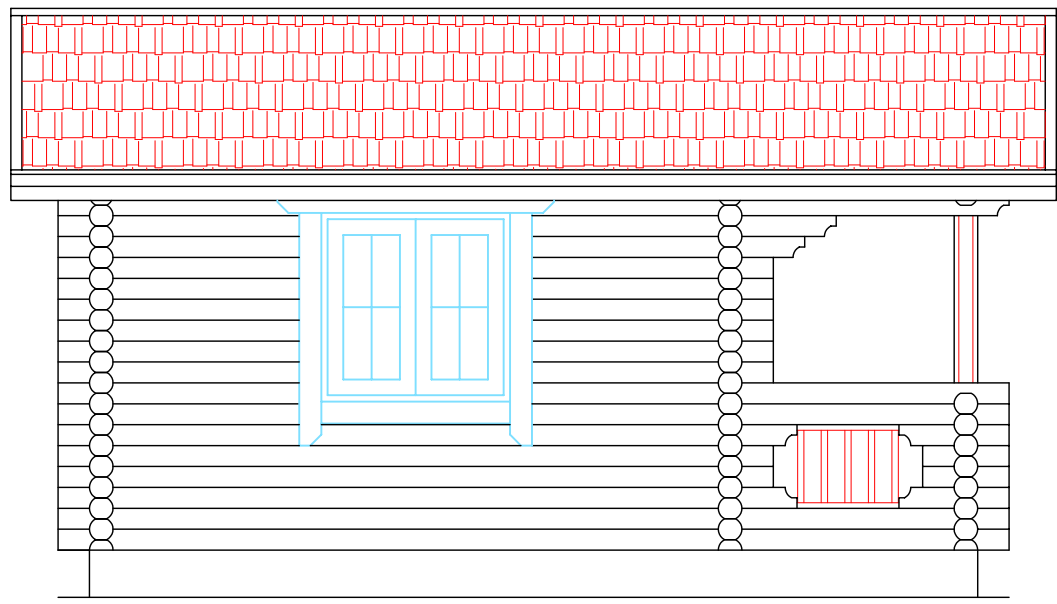

Section -C

SECTIONS		Page:4.1.2
Drawn by: Tarmo Tigane	STUDLAND 4x4	Measure: 1:50

+3.44

±0.00

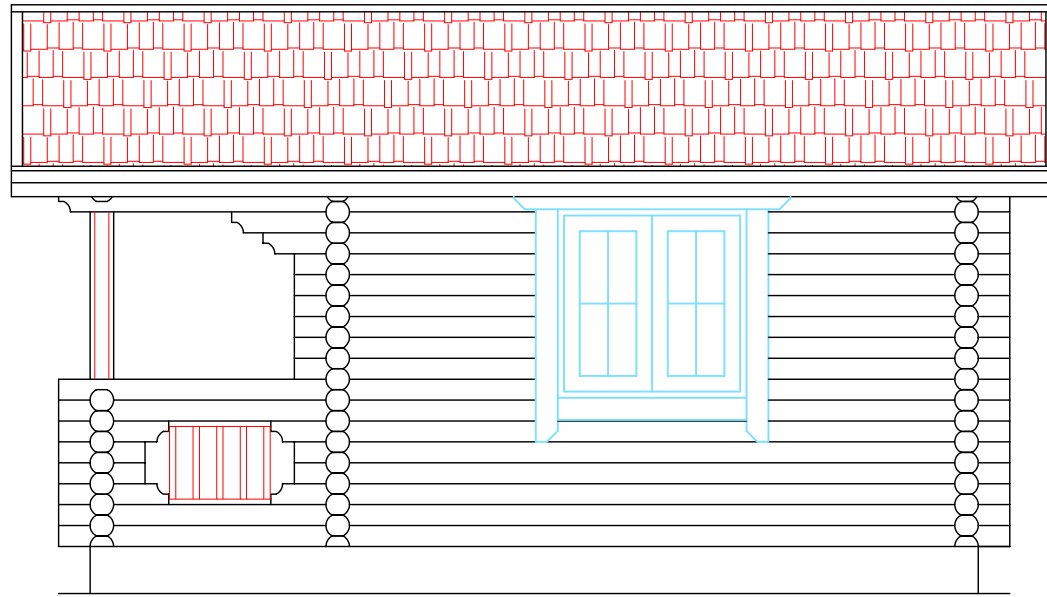

Section -D

SECTIONS		Page:4.1.3
Drawn by: Tarmo Tigane	STUDLAND 4x4	Measure: 1:50

Section-C

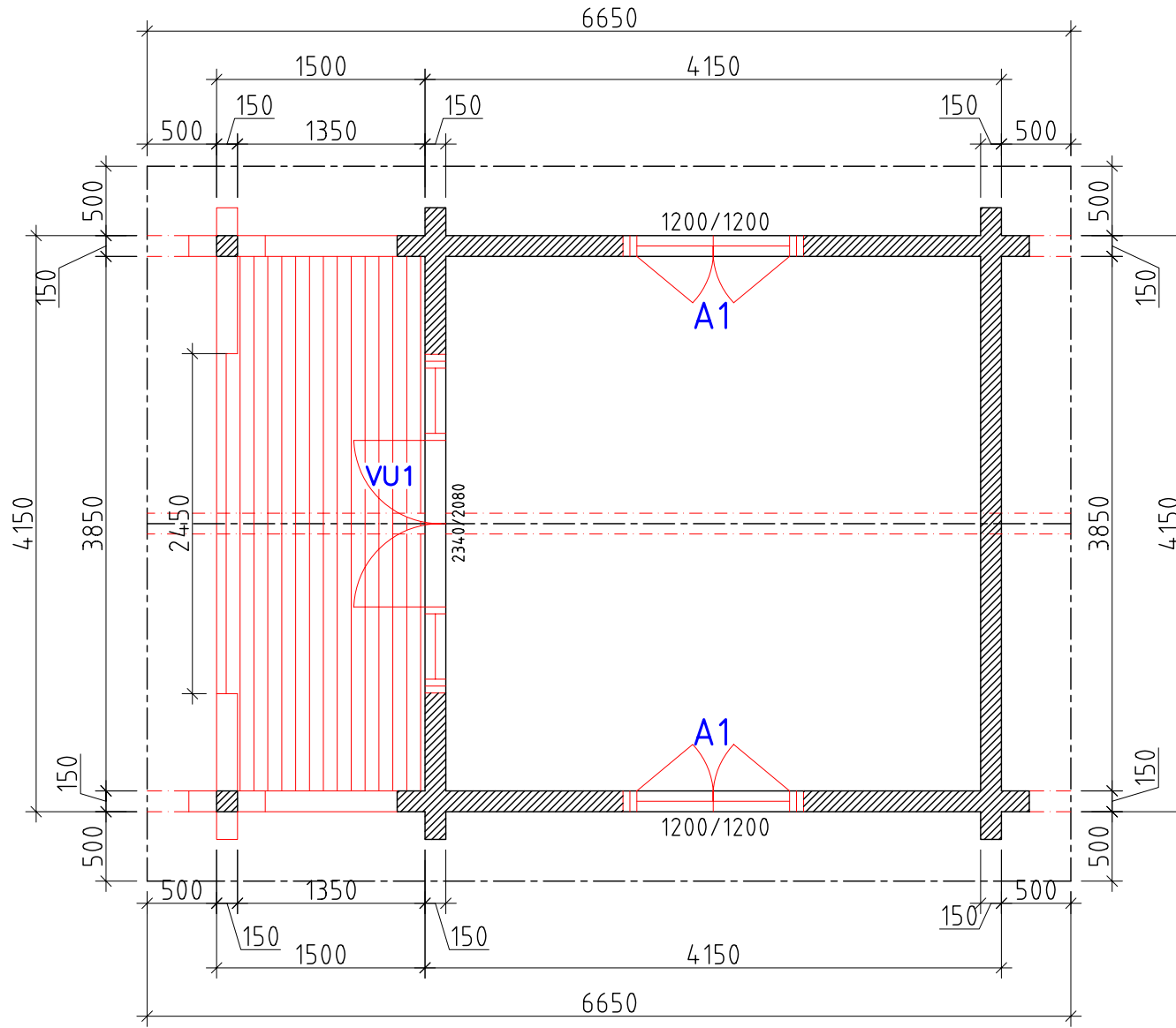
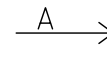

Section -A

Section -B

Section-D

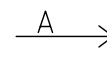

GROUND PLAN		Page:4.2
Drawn by: Tarmo Tigane	STUDLAND 4x4	Measure: 1:50

Section-C

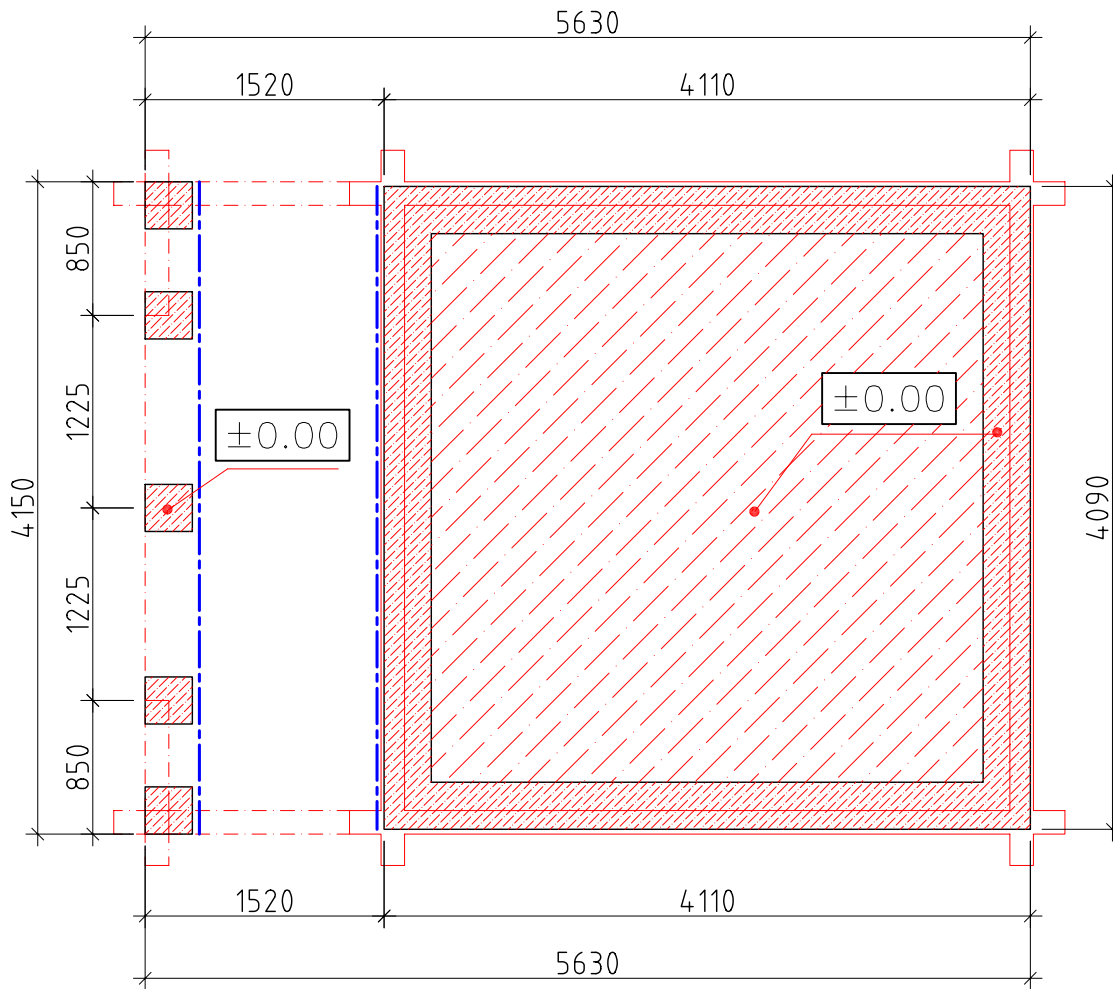

Section -A

Section -B

Section-D

Foundation plan $\pm 0.000$		Page:4.5
Drawn by: Tarmo Tigane	STUDLAND 4x4	Measure: 1:50